

PRO TOUR

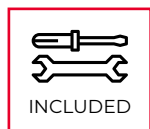

COMPLIANT WITH
DIN 75302:2019









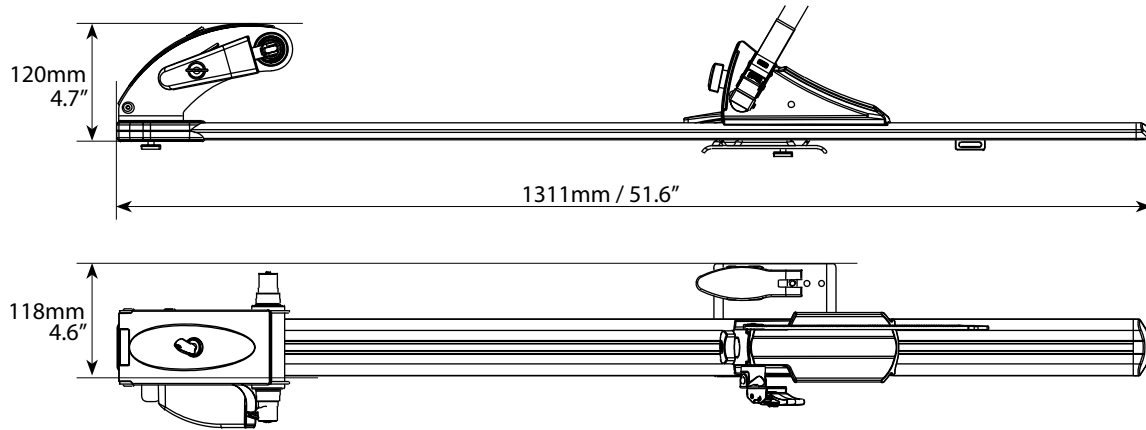

Portabici da tetto professionale realizzato in alluminio, pensato per chi preferisce caricare la propria bici direttamente sulle barre. È dotato di un sistema di aggancio della forcella sia tradizionale che ammortizzata. Consigliato per le bici con telaio in carbonio e indicato anche per quelle con freno a disco anteriore. Dotato di doppio sistema antifurto.

Professional aluminium bike rack conceived for those who prefer carrying their bike directly on the roof bars. Both traditional and cushioned forks can be attached to the locking system. It is recommended for bikes with carbon frame and/or with front disc brake. Equipped with double anti-theft system.



Art.000086100000

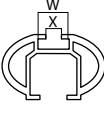



Pro tour	Art.000086100000
 Peso prodotto Product weight	2,45kg/5.4lb
Materiale Material	Alluminio Aluminium
 Portata massima Max load	max 17kg / 37lb
 Antifurto portabici Anti-theft for the bike rack	✓
 Antifurto bici Anti-theft for the bike	✓
 Sistema di montaggio alle barre Fixing system to the roof bars	 T-system X: min 6,5mm/0.3" W: 20mm/0.8"
	x1
E-bike	✓
Fat bike	✓

COMPATIBILITÀ BICI
BIKE COMPATIBILITY

Art.				
PRO TOUR	-	min 22" max 29"	max 110mm/4.3"	max 1200mm/47.2"



OPTIONAL KIT ADAPTER

Montaggio rapido della bici tramite adattatori intercambiabili. Kit con perno passante da $\varnothing 9 \times 100 \text{mm} / \varnothing 0.3 \times 4 \text{''}$ incluso.

Quick assembly of the bike via interchangeable adapters. Kit with $\varnothing 9 \times 100 \text{mm} / \varnothing 0.3 \times 4 \text{''}$ thru-axle included.

Quick release $\varnothing 9 \times 100 \text{mm} / \varnothing 0.3 \times 4 \text{''}$
(Incluso / Included)

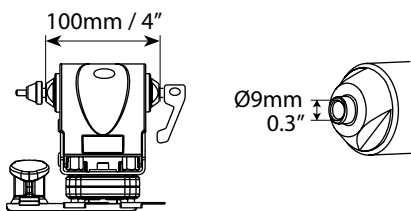

$\varnothing 20 \times 110 \text{mm} / \varnothing 0.8 \times 4.3 \text{''}$
Art. 000087000000

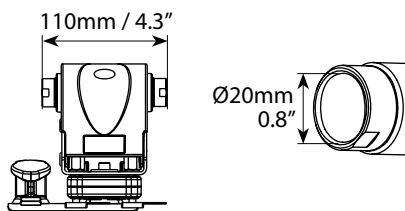

$\varnothing 15 \times 110 \text{mm} / \varnothing 0.6 \times 4.3 \text{''}$
Art. 000094600000

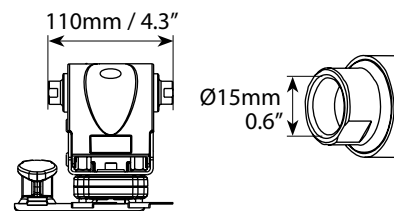

$\varnothing 15 \times 100 \text{mm} / \varnothing 0.6 \times 4 \text{''}$
Art. 000086900000

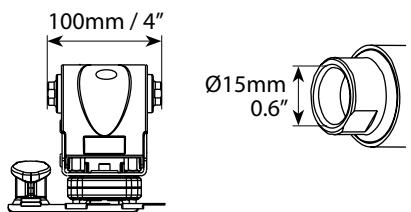

$\varnothing 15 \times 150 \text{mm} / \varnothing 0.6 \times 6 \text{''}$
Art. 000087100000

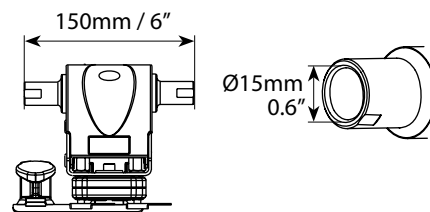

$\varnothing 12 \times 100 \text{mm} / \varnothing 0.5 \times 4 \text{''}$
Art. 000094800000

