

PORTABICI  
BIKE CARRIERS  
PORTABICICLETAS  
PORTE-VÉLOS  
FAHRRADTRÄGER

**MENABO**  
*free time on the move*

## MISTRAL

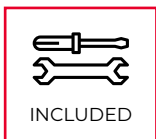





Portabici posteriore in acciaio adatto al trasporto di tre biciclette. Sicuro, semplice e rapido da montare. Una volta chiuso, occupa pochissimo spazio.

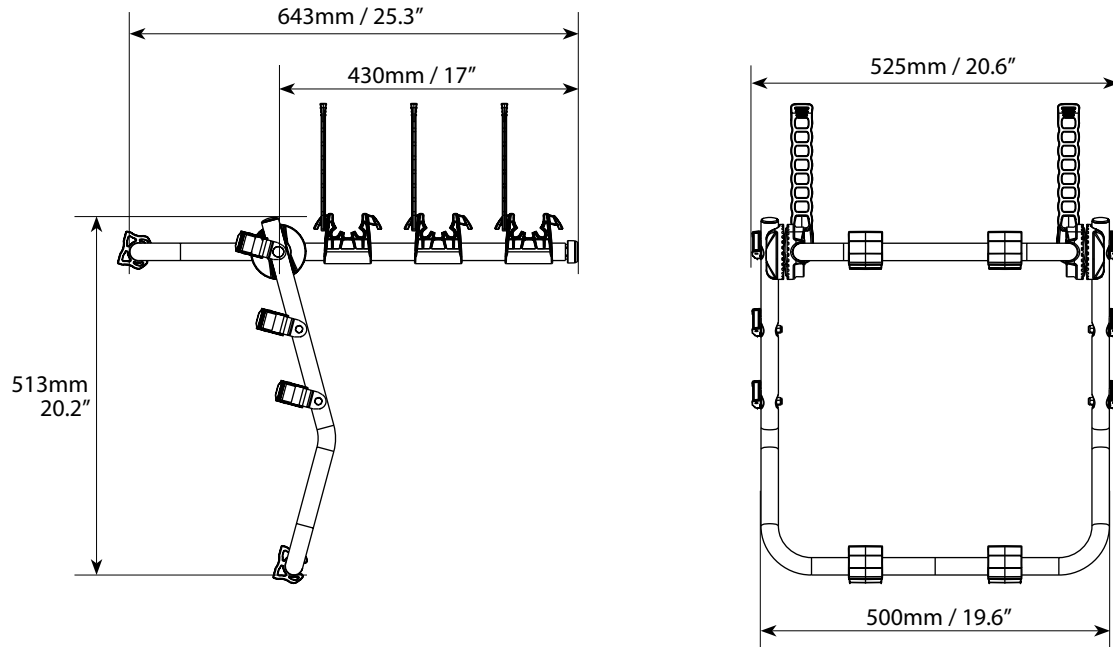





Rear mounted bike rack, completely steel made, suitable for carrying three bikes. Easy and quick to install on the car's hatch, it is extremely safe. When folded, it takes very few space.





Mistral	Art. 000009000000
 Peso prodotto Product weight	3,7kg/8lb
Materiale Material	Acciaio Steel
 Portata massima Max load	max 45kg / 99lb
 Antifurto portabici Anti-theft for the bike rack	x
 Antifurto bici Anti-theft for the bike	x
	3
E-bike	x
Fat bike	✓

**COMPATIBILITÀ BICI  
BIKE COMPATIBILITY**

Mod.					
MISTRAL	 min: 25mm/1" max: 60mm/2.3"	 min: 30x50mm/ 1.2x2" max: 50x75mm/ 2x3"	No limit	No limit	No limit

